



SUN n FUN
AEROSPACE EXPO

EXHIBIT OPPORTUNITIES



APRIL 14-19, 2026



FLYSNF.ORG

CONTENTS

Exhibit Opportunities	3
Sponsorship Opportunities.....	5
Advertising Opportunities	6
Event Stats	8
Exhibit Spaces & Amenities.....	9
Exhibit Price Sheet	11
Important Dates & Deadlines.....	12
SUN 'n FUN Operations Support	13
Approved Suppliers/Services	14
Private Venue Rentals	15
Caterers.....	16
Internet & WiFi Options	17
SUN 'n FUN Rules & Regulations	18
SUN 'n FUN Insurance Requirements.....	20
Exhibit Maps	



EXHIBIT OPPORTUNITIES



Greetings from the Aerospace Center for Excellence (ACE), home of the SUN 'n FUN Aerospace Expo in Lakeland, Florida! Our Mission here at ACE is to ENGAGE, EDUCATE and ACCELERATE the next Generation of Aerospace Professionals. Your participation as an exhibitor during the SUN 'n FUN Aerospace Expo helps us deliver on that mission. In return, we change the lives of countless young people through the Magic of Aviation.

As you read, the team is planning the 52nd annual SUN 'n FUN Aerospace Expo held on April 14–19, 2026. We aim to deliver the best possible exhibitor experience during our event. If you were an exhibitor last year, we thank you for joining us and look forward to welcoming you back in 2026.

Please reach out to the team at any time leading up to and during the event. We are here to help and make your exhibitor experience an unforgettable one!

Gene Conrad - President & CEO -
Aerospace Center for Excellence and SUN 'n FUN

Check out flsfnf.org/exhibits for additional information about exhibitor opportunities during the SUN 'n FUN Aerospace Expo. We have a team ready to work with you and answer all of your questions. Let us connect you to SUN 'n FUN in new ways and most importantly, enjoy your experience at our Aerospace Expo!

MAXIMIZE THE EXPOSURE OF YOUR PRODUCTS AND SERVICES

- Advertise in our Email Marketing Campaigns, In-Flight Guide, Event Map, Mobile App, or Website at flsynf.org.
- Connect with our pilots by participating in our Fly-In Style Pilot Program.
- Host potential and current clients at various venues!
- Be the center of attention for 750 media reps worldwide and host a breakfast or lunch at the media center.
- Sponsor venues, events, or activities during the week to gain exposure to your targeted client base.
- Share news about your business on our Exhibitor News Listing.



Sponsorship Opportunities

Discover exceptional sponsorship opportunities at SUN 'n FUN, where your brand can soar to New Heights! Align with one of the largest aviation events globally and gain unparalleled exposure to a diverse and enthusiastic audience. From high-impact branding to exclusive access engagement, our sponsorship packages will elevate your presence and connect you with industry leaders, aviation enthusiasts, and the next generation of aerospace professionals. Join us in making a lasting impression in shaping the future of Aviation!

Opportunities Include:

- Advertising and Media Presence
- Branding Recognition
- Golf Cart Transportation
- Naming Rights
- Venues for Hosting Meetings & Events
- VIP/Exclusive Access
- Year-round Recognition

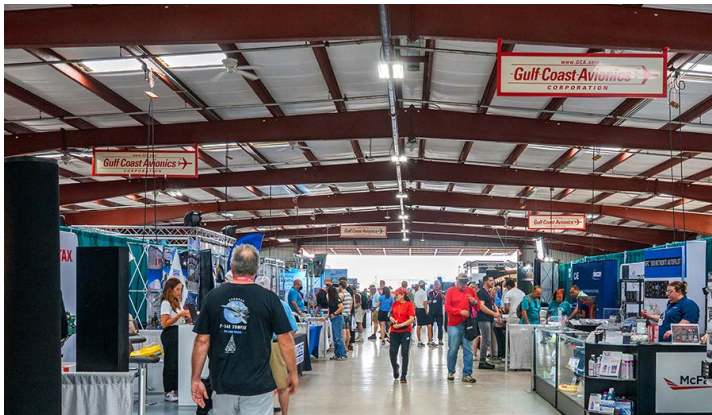

CHECK OUT OUR SPONSOR PACKET AT FLYSNF.ORG FOR MORE SPONSORSHIP OPPORTUNITIES or contact Sheena Banker, Business Development Manager at 863-904-4061 or by email sbanker@flysnf.org

Advertising Opportunities

Promote your business during the SUN 'n FUN Aerospace Expo with several event advertising opportunities and gain year-round visibility by advertising throughout the year on the SUN 'n FUN website! Our site is visited by aviation enthusiasts worldwide with interests in all things SUN 'n FUN and the Aerospace Center for Excellence.

Chose from printed event publications such as the In-Flight Guide and Expo Map, distributed to over 30,000 guests during the week. They not only provide event information, but also a souvenir to take home.

Review our advertising opportunities by accessing the Advertising Packet at Flynfnf.org. For more info call **863-904-4061** or email advertise@flynfnf.org.

Check Out Some Examples Here!

EMAIL NEWSLETTER

EXPO MAP

IN-FLIGHT GUIDE

MOBILE APP

PATHWAY ADS

WEBSITE

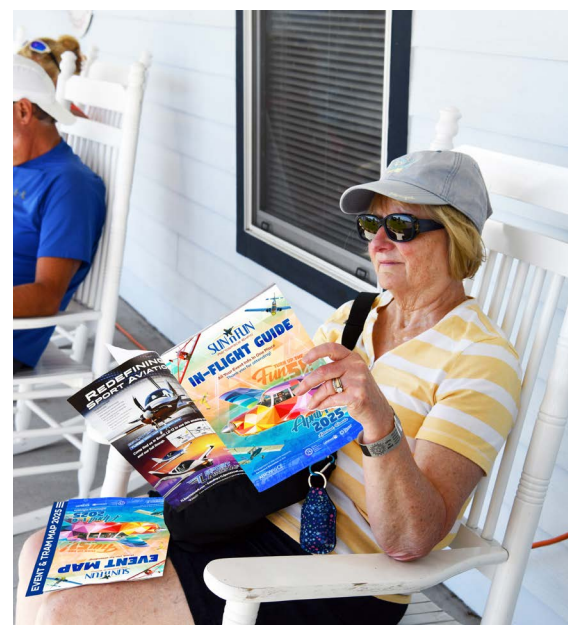



Advertising Data

MOBILE APP

Users 17K	Page Views 85.5K	Saved Sessions 42K
Exhibitor Profile Interactions 30K	Banner Clicks 6.5K	



73% 
27% 

EMAIL

Subscribers
96K
Avg. Click Rate
2%
Avg. Open Rate
50%







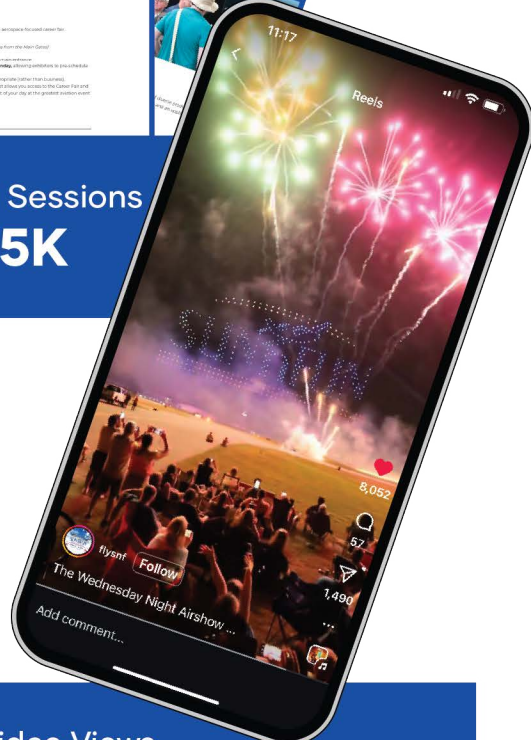



WEBSITE

Users 653K	Event Count 4.7M	New Visitors 79%	Engaged Sessions 485K
----------------------	----------------------------	----------------------------	---------------------------------



SOCIAL MEDIA

 161K  7K	 24.8K  2.5K
 80.4K  7K	 4.5K  2K

Reach 5M	Collabs 30	Profile Views 334K	Video Views 12M
--------------------	----------------------	------------------------------	---------------------------

Event Stats

Attendance
210K

Volunteers
3.6K

Exhibitors
561

Registered Aircraft
4K

Aircraft Operations
8K



Avg. Age Range
35-65



Avg. Income
\$100-150K



FL Residents
65%

RV/Tent Camping
15.5K

Certificated Pilots
55%



TOP 10 STATES

Florida
Georgia
North Carolina
Texas
South Carolina
New York
Pennsylvania
Tennessee
Virginia
Ohio

TOP 10 COUNTRIES

United States
Brazil
Canada
Germany
Argentina
United Kingdom
Mexico
Switzerland
Colombia
Austria

Guests came from all 50 states and 78 different countries!

Sponsors
90

Media Guests
700

Preferred Seating
6K

9/27 Club Guests
3K

Youth Engagement
18K

Exhibit Spaces & Amenities

Enjoy access to the Exhibit Office and Oasis located between Hangars B and C.

Each exhibit space includes staff credentials and access to the pink exhibitor parking lot 2, marked on the next page. Your parking pass also allows direct access to the exhibit areas for loading/unloading supplies before 9 a.m. and after 5 p.m. daily. (Exception: 6 p.m. on closing day.)

Priority exhibit space is given to aviation-based companies to keep the focus on SUN 'n FUN to attract a highly interested and motivated audience ready to do business with our exhibitors.

Tents, shipping services and more can be found on our **APPROVED SUPPLIERS/SERVICES List** on **page 14**.

If you are interested in becoming a NEW Exhibitor, please complete the Exhibitor Application online at <https://flysnf.org/exhibitors/why-exhibit/#exhapp>. If you have questions, please contact the Exhibits Director, Ann Gaines, at **863-904-4026** or email Exhibits@flysnf.org.

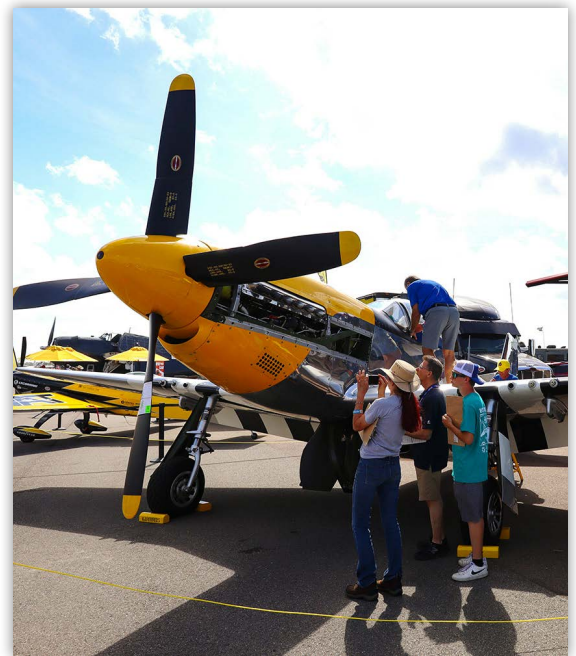

Indoor Exhibits

Four 20,000 sq. ft. hangars at "Show Center" offer 10x10 and 10x20 exhibit spaces including electricity, back and side curtain, pipe & drape, a sign and credentials. Food vendors and restrooms are located within a short walking distance for the convenience of guests and exhibitors alike.

Outdoor Exhibits

Exhibit spaces are available in various sizes and locations. Footprints range from 100 to 10,000 sq. ft. and are priced accordingly. Most spaces include electricity and may have wireless internet capability. Please inquire for details about a specific exhibit space.

Exhibit Spaces Include

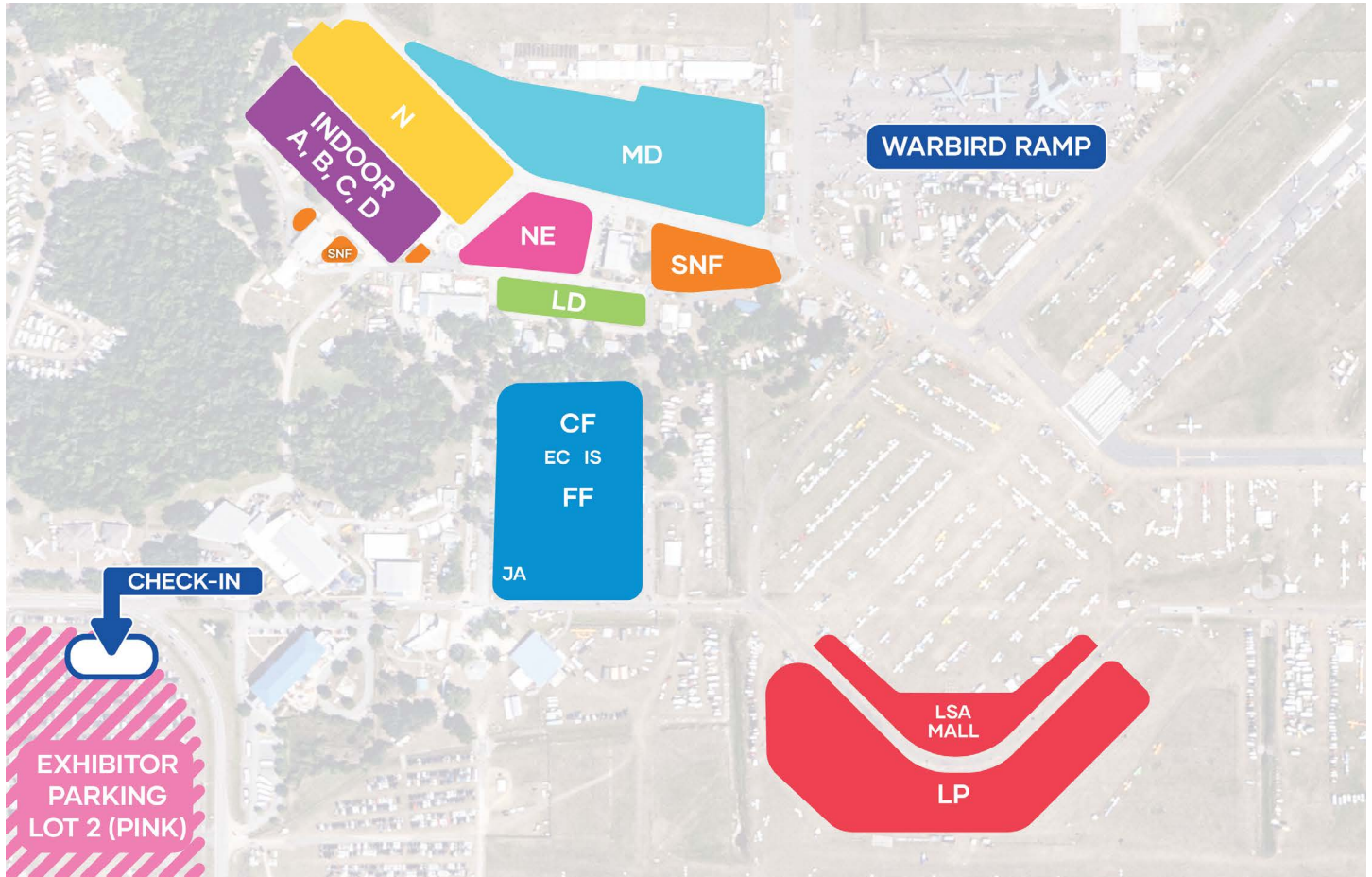

Future 'n Flight Plaza (FF)

Large spaces for aircraft and exhibitors requiring a large footprint, just north of the SUN 'n FUN main gate; also the location of the Career Fair, Junior ACEs, Flight Simulation Experience, Innovation Showcase, and Forums.

Career Fair (CF)

Located in a dedicated air-conditioned venue within the Future 'n Flight Plaza. This 6-day expo allows exhibitors to pre-schedule meetings or candidate interviews.

Flight Path Education Center (EC)

Located in a dedicated air-conditioned venue within the Future 'n Flight Plaza. This area is focused on educational programs as well as flight instruction within the aviation and aerospace industry.

Large Display (LD)

Aircraft or other general exhibitors requiring more spaces along Laird Blvd. south of the FAA building.

Light Aircraft, Rotocraft, Homebuilt, Experimental, & EVTOL (LP)

Large spaces just south of vintage & classic aircraft parking along a major tram route. Includes an FAA-approved grass strip with daily flight activity.

Manufacturers Display (MD)

Reserved primarily for aircraft manufacturers, the northern most outdoor exhibit area just south of runway 10/28.

North Exhibits (N)

Exhibitors and small aircraft, just north of the exhibit hangar doors facing runway and airshow box.

North East Exhibits (NE)

Exhibitors and some aircraft, between Hangar A and FAA building.

SUN 'n FUN Exhibits (SNF)

Large spaces primarily for aircraft manufacturers east of the FAA building and south of the Manufacturers Display area.

Exhibit Price Sheet

Each exhibit space includes a minimum of 20 amp/120 volt electric service. No electric in (LP) or (AC) Exhibits

A, B, C, D Hangars

6 Exhibitor & 1 Parking pass per booth	
10x10 in-row	(\$2,580)
10x10 end cap	(\$2,700)
10x20 corner	(\$3,460)

Aircraft Spaces (AC)

6 Exhibitor & 1 Parking pass per booth
One aircraft and 10x10 tent permitted (\$1,750)

North East Exhibits (NE)

6 Exhibitor & 1 Parking pass per booth	
NE-001 & 012 - 20x40	(\$2,005)
All other spaces - 20x30	(\$1,505)
NE-059 only available with 058 or 060	

Light Plane (LP)

4 Exhibitor & 1 Parking pass per booth	
50x50 Outer spaces	(\$1,270)
50x50 Inner spaces	(\$1,185)

Future 'n Flight Plaza (FF)

6 or 9 Exhibitor & 2 Parking passes per booth	
2,800 sq. ft.	(\$1,650)
5,625 sq. ft.	(\$2,700)

Career Fair (CF)

4 Exhibitor & 1 Parking pass per booth	
10x10 additional booth	(\$1,030)
10x10 single booth	(\$2,060)

Flight Path Education Center (EC)

6 Exhibitor & 1 Parking pass per booth	
10x10 single booth	(\$2,580)
10x15 single booth	(\$3,870)

Large Display (LD)

12 Exhibitor & 2 Parking passes per booth	
LD-002 thru 005	(\$4,220)
LD-008 thru 011	(\$4,220)
LD-001	(\$5,895)
LD-006	(\$4,765)
LD-007	(\$6,150)
LD-012	(\$6,665)
LD-013	(\$6,665)

North Exhibits (N)

6 Exhibitor & 1 Parking pass per booth

N-001 thru 006	20x30 (\$1,505)	N-031	40x30 (\$3,010)	N-067, 068	40x20 (\$2,005)
N-007	40x30 (\$3,010)	N-032	40x25 (\$2,510)	N-069 thru 078	30x20 (\$1,505)
N-008 thru 011	30x30 (\$2,255)	N-033 thru 042	30x25 (\$1,880)	N-079, 080	40x20 (\$2,005)
N-012, 013	10x10 (\$1,080)	N-043, 044	40x25 (\$2,510)	N-081 thru 090	30x20 (\$1,505)
N-014 thru 018	30x25 (\$1,880)	N-045 thru 054	30x25 (\$1,880)	N-091, 092	40x20 (\$2,005)
N-019, 020	40x25 (\$2,510)	N-055	40x25 (\$2,510)	N-093 thru 102	30x20 (\$1,505)
N-021 thru 025	30x25 (\$1,880)	N-056	40x20 (\$2,005)	N-103	40x20 (\$2,005)
N-026 thru 030	30x30 (\$2,255)	N-057 thru 066	30x20 (\$1,505)		

SUN 'n FUN Exhibits (SNF)

SNF-001 (\$12,130)	18 Exhibitor & 2 Parking passes	SNF-005 (\$4,360)	} 9 Exhibitor & 2 Parking passes
SNF-002 (\$7,910)	12 Exhibitor & 2 Parking passes	SNF-006 (\$5,685)	
SNF-003 (\$25,000)	} 18 Exhibitor & 2 Parking passes	SNF-007 (\$4,965)	
SNF-004 (\$20,600)		SNF-008 (\$5,685)	

Manufacturer's Display (MD)

MD-A's - 7,200-10,000 sq. ft.	(\$10,545)	} 18 Exhibitor & 2 Parking passes
MD-B's - 5,100-7,175 sq. ft.	(\$7,910)	
MD-C's - 5,625 sq. ft.	(\$7,910)	
MD-D's - 2,500 sq. ft.	(\$4,360)	12 Exhibitor & 2 Parking passes

Important Dates & Deadlines

September 15, 2025	Exhibitor Application and Payment Due
October 1 Forward	First-time Exhibitor Applications Issued
January 31, 2026	Tent Discount Deadline Booth Cancellation Deadline to Recieve 75% Refund
February 28, 2026	Booth Cancellation Deadline to Recieve 50% Refund
March 1, 2026	Booth Cancellation – No Refunds Certificates of Insurance Due Submit Exhibitor Contact Information
March 3, 2026	Advertising Deadlines
March 6, 2026	GES Rental Discount Deadline
April 3, 2026	Exhibitor Internet Access Order Deadline (see page 17)
April 10, 2026	Sponsor Only Set-Up Indoor, No Security
April 11–12, 2026	8 am–5 pm: Exhibit Set-Up and Credential Pick-Up
April 13, 2026	8 am–8 pm: Exhibit Set-Up and Credential Pick-Up
April 14, 2026	5 pm–6 pm: Exhibitor Welcome Reception
April 14–19, 2026	8 am–9 am: Exhibit Hangars Open to Exhibitors Only 9 am–5 pm: Exhibits Open to the Public
April 16, 2026	7 am–9:30 pm: Exhibitor Appreciation Breakfast (Tickets Available at the Bonnie Perkins Exhibit Office)
April 19, 2026	2 pm–6 pm: Aircraft Towing for Departure 2 pm: Golf Cart Shuttle to Parking Lot From Exhibit Office (Southside of Exhibit Hangars) 2 pm–9 pm Hangars Open to Exhibitors Only for Breakdown 6 pm: Exhibitor Vehicles Allowed into the Exhibit Area
April 20, 2026	8 am–5pm: Hangars Open for Continued Breakdown
April 21, 2026	8 am–12pm: Hangars Open for Continued Breakdown

BREAKDOWN POLICY

Breakdown of exhibit booth/tent prior to 2 pm on Sunday, April 19, 2026 IS PROHIBITED.

We will tug or otherwise assist aircraft in departing the Outdoor Exhibits Areas beginning at 2 pm on Sunday, April 19.

GES will begin positioning trailers in front of Exhibit Hangars A, B, C, and D at 2 pm. Crates will be delivered between 2–6 pm.

Vehicles are permitted access beginning at 6 pm.

Hangars will remain open until 9 pm on Sunday, April 19, and reopen on Monday, April 20 at 8 am (estimated time).

CREDENTIAL POLICY

Access control is an important element of the security program at the SUN 'n FUN Aerospace Expo. Your credential for access to our site is a lanyard and **must be visibly worn at all times**. If you or your team do not have your credentials, you will not be allowed access to the SUN 'n FUN Aerospace Expo Campus.

If you have someone attending who needs lanyards from your allotment, you may leave their name on an envelope at the exhibit/media/sponsor check-in building, thru Tuesday, April 14 for convenient pick-up.

If you need additional credentials (daily/weekly wristband), they may be purchased at either the exhibit check-in or the main registration building.

Will Call Windows 1 & 2 are open from 8am–6pm, daily, Tuesday thru Sunday. No entry to the event will be permitted without an Exhibitor Credential or wristband.

SUN 'n FUN Operations Support

Advertising

863-904-4061 • advertise@flysnf.org

Exhibits

Ann Gaines
863-904-4026 • againes@flysnf.org

Flightline Chalets/Private Events/ Catering

Samantha Meadows
863-904-4024 • smeadows@flysnf.org

Fly-By Showcase

BJ Kirby
352-344-5678 • bj@bjkirby.com

Forums

Laura Vaughn
863-904-4003 • llvaughn@flysnf.org

Internet/Wifi/Audiovisual

863-904-4009 • IT@flysnf.org

Lightplane/Paradise City

Gary Furdell
239-357-9551 • ahcaman@msn.com

Maintenance

Tim Wells
863-904-4021 • twells@flysnf.org

Marketing

Melissa Goodson
863-370-4928 • mgoodson@flysnf.org

Media Center/Press Conferences

Orathai Northern
media@flysnf.org

Sponsorships

Vice President Strategic Partnerships

Jane Winter
781-795-2476 • jwinter@flysnf.org

Sponsorships & Advertising

Sheena Banker
863-904-4061 • sbanker@flysnf.org

Aerospace Center for Excellence Vice President & COO

Eric Crump
863-904-6848 • ecrump@flysnf.org



Exhibitor Web Graphics

Once you become an OFFICIAL Exhibitor at the SUN 'n FUN Aerospace Expo, you will have the opportunity to download the SUN 'n FUN exhibitor graphic to display on your website. To include your booth number in the graphic, [please visit flysnf.org/exhibitors/exhibitor-resources/](https://flysnf.org/exhibitors/exhibitor-resources/)

Approved Suppliers/Services

Audio Visual

Ultra Production Group
James Kessell • 800-549-UPG1

ultraproductiongroup.com/sun-n-fun
ultraproductiongroup.com

Air-Conditioning/Generator Rental & Electrical

SUN 'n FUN Staff
Mike Woodley • 586-944-7101

sparky@flsynf.org

Campground Services

Pumpouts/potable water delivery must be ordered online from: mysnf.org/pumpout

- Pump-out Service: \$57
- Potable Water Delivery: \$73 (1-50 gal), \$125 (51+ gal)
- Same Day Service for Requests Before 12pm
- Requests after 12pm serviced next day

Flowers

Flower Cart

Antonio Marreo • 813-687-1783
1125 Lakeland Hills Blvd, Lakeland, FL 33805

flowercartoflakeland@gmail.com
shopthecart.com

Ice Sales

Ice is available for purchase starting Saturday, April 11, 2026, 8 am–5 pm at the Bonnie Perkins Exhibit Office.

On-Site Aircraft Detailing

Next Level Aviation Detailing

Jake Heron • 352-816-6547
6590 SW 135th Ct. Rd., Ocala, FL 34481

jake.nextlevelaviationdetail@gmail.com
www.nextlevelaviationdetailing.com
[instagram.com/nextlevelaviationdetailing](https://www.instagram.com/nextlevelaviationdetailing)

On-Site Security

The Lakeland Police Department will be on-site 24 hours.

After Hours Issues, Please call 863-644-2431

Lee Jordan, SUN 'n FUN Security • 863-286-5323

Plant Rental

Johnson Plant Rentals
Peggi Slappey • 813-323-6458

peggislappey@yahoo.com

Printing Services

Sir Speedy

Nicholas Hargrave • 863-647-5500
4175 S. Pipkin Rd. Unit 108, Lakeland FL 33811

orders@sirspeedylakeland.com
sirspeedylakeland.com

Tables, Chairs, Carpet, & Astro Turf, Labor, Shipping, & Freight Receiving

GES Expo Services

Ben Cramer - bcramer@ges.com
Stacy Muller - smuller@ges.com

National Service Center: 800-801-7648
M-F 6 am–4 pm PST

[GES Ordering](#) • [GES Quick Facts](#)

Tent Rental

iRent Everything

833-473-6862 (Option 1)

sales@irenteverything.com
irenteverything.com

Tug Services

Charlie Bellino • 727-272-7261

Services Available During SUN 'n FUN:

- Saturday–Saturday, 7 am–7 pm
- Tuesday Night Concert (times may vary)
- Wed & Sat Night Airshows (times may vary)
- Sunday Breakdown 2 pm–6 pm
- Mon–Wed (post show) 8 am–3 pm

More info can be found at flsynf.org or contact Ann Gaines - Exhibits Director at **863-904-4026** or email Exhibits@flsynf.org.

Private Venue Rentals

Prop 75

A centralized gathering place. This venue offers an air-conditioned space, restrooms, and small kitchenette! Inside capacity 150 banquet-style. Includes A/V Package (podium, plug-n-play Smart TV)

Contact Samantha Meadows at **863-904-4024** or **smeadows@flysnf.org** for more information.



Aerospace Pavilion

An outdoor amphitheater with a stage that can host up to 1,000 attendees under cover. Includes A/V Package (podium, plug-n-play Smart TV)

Flightline Chalets

Looking for a way to impress your clients? Rent a week-long Flightline Chalet during SUN 'n FUN and entertain them with a front-row seat to the airshow action!

- Chalet tents are located north of the Manufacturers Display Exhibits Area with Premium Airshow Seating
- Catering options from exclusive food vendors only
- Air-conditioned restrooms
- Outdoor patio seating
- Air-conditioned tents

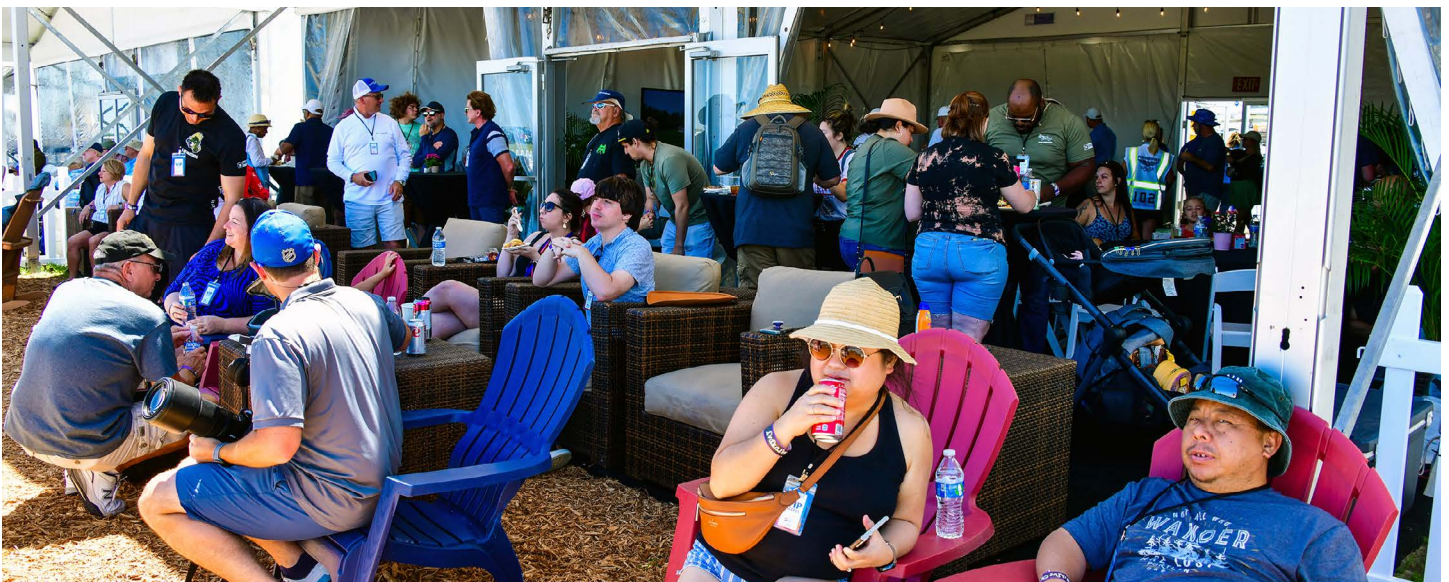

Caterers

Frescos

Tina Calhoun • 863-608-1347
132 S. Kentucky Ave., Lakeland, FL 33801

catering@frescoslakeland.com
frescoslakeland.com

Fuzzy's Taco Shop

Erica Hudgens • 813-728-7309
3950 S Florida Ave., Lakeland, FL 33813

erica@ftbservices.com
fuzzystacoshop.com

High Steaks Catering

Michelle Holley • 813-461-0888
17420 US Highway 41 N., Lutz, FL 33549

michelle@highsteakscatering.com

Mission BBQ

Dana Clifford • 863-877-7800 or 863-535-8433, Ext.1
4014 S Florida Ave., Lakeland, FL 33813

Catering33813@mission-bbq.com
mission-bbq.com

Nineteen 61

863-688-1961
215 East Main St., Lakeland, FL 33801

catering@nineteen61.com
nineteen61.com

TLC Catering

Terrie Lobb • 863-533-6483
1239 E Main St., Bartow, FL 33830

terrie@tlccatering.com
tlccatering.com

The Catering Company of Central Florida

Christa Robinson • 863-207-7057
1239 E Main St., Bartow, FL 33830

thecateringco@hotmail.com
thecateringcompanyofcentralfl.com

TPI Event Solutions

Abby Thomas • 252-671-1062 or 252-636-0033
3310 Trent Rd., New Bern, NC 28562

abby@tpieventsolutions.com
tpieventsolutions.com

(Only available during the
Annual Aerospace Expo)

*****All onsite events during the SUN 'n FUN Aerospace Expo must use a caterer from our Preferred Catering List. Any non-approved caterers or third-party delivery services—including EZCater, DoorDash Catering, Uber Eats Catering, and Grubhub Catering—will NOT be permitted on the grounds*****



If you would like to host an event, you must confirm your reservation with the SUN 'n FUN Events Director, Samantha Meadows at **863-904-4024** or **smeadows@flsynf.org**.

Wired Internet & WiFi Options

SUN 'n FUN is proud to offer a variety of high-speed internet services to meet the needs of our exhibitors, vendors, and guests. In addition to the premium exhibitor exclusive services below, we also offer a wireless guest network in select areas across the campus. This guest network is limited to 10Mbps, not guaranteed, and is available to everyone including guests. For a better Internet experience, choose from one of the options below.

All exhibitors will receive cards within their Exhibitor Packet explaining how to take full advantage of our IT services this year. If you have any questions, please call our IT department at 863-904-4009 or email IT@flsysnf.org.

Exhibitor Wired Internet: \$750

- Guaranteed bandwidth 250Mbps Up/Down
- Exclusive to exhibitors
- Dedicated, private VLAN per exhibitor
- Dedicated ethernet cable with standard termination
- Priority support with a dedicated team of IT technicians
- Additional network equipment like switches and patch cables available as supplies last
- Access to the premium Exhibitor Wireless Internet included

Exhibitor Wireless Internet: \$200

- Guaranteed bandwidth 40Mbps
- Exclusive to exhibitors
- Priority support with a dedicated team of IT technicians

To take advantage of our premium Internet services, you must **submit an order through the Exhibitor Portal by March 31st, 2026**: <https://systems.aceedu.org/exhibitorportal>

STAY CONNECTED - STAY INFORMED

FOLLOW US!



**SUBSCRIBE TO OUR
NEWSLETTER
SCAN THE QR CODE**



Text Updates During the Event

- ▶ Text EXHIBITOR to 863-375-8862 for exhibitor-specific updates
- ▶ Text WEATHER to 863-375-8862 for weather and emergency alerts

Carrier message rates may apply. Text STOP to 863-375-8862 to unsubscribe from all messages.



SUN 'N FUN RULES & REGULATIONS

EXHIBITOR'S ON-SITE REPRESENTATIVE: Exhibitor, at all times during the Expo shall have its designated on-site representative available to SUN 'n FUN for the purpose of making all decisions necessary on behalf of Exhibitor at or during the Expo. Exhibitor's On-Site Representative shall have all authority to represent and/or commit Exhibitor at or during the Expo, and SUN 'n FUN may rely without reservation upon all such representations and/or commitments

EXHIBITOR OFFICE LOCATION: Check in upon arrival at the Exhibitor Welcome Center, open Sat.- Mon. prior to Expo, located off Medulla Road in the Exhibit Parking Lot. Exhibit Office throughout the Expo is located on the south end of B and C Hangar.

SET UP AND INSTALLATION OF EXHIBITS: Installation of exhibits will be permitted starting Saturday, April 11th and Sunday, April 12th, 2026 from 8:00 a.m. to 5:00 p.m. and Monday, April 13th, 2026 from 8:00 a.m. to 8:00 p.m. No Light Plane landings before Monday April 13th, 2026 in Paradise City.

HOURS OF OPERATION: Shall be from 9 a.m. - 5 p.m., Tuesday-Saturday. Sunday breakdown 2:00 p.m. Indoor Exhibit Hangars will open at 8:00 a.m. Tuesday thru Sunday for Exhibitors only, to prepare for the day's business. All Exhibit Spaces must be cleared and all displays removed by noon on Tuesday, April 21st, 2026. Opening and closing times of Indoor Exhibit hangers shall be enforced for Exhibitors' protection.

FEES: Exhibit Space fee includes the cost of a Polk County Occupational License and Exhibitor's credentials per Exhibit Space. Indoor displays include back drapes, side curtains and sign. Additional credentials may be purchased at the exhibit check-in or Main Registration building.

RESERVING EXHIBIT SPACE: SUN 'n FUN reserves the right to relocate Exhibitor to another Exhibit Space at any time and from time to time, either before or during the Expo. Full payment, received by September 15th, 2025, will guarantee an Exhibit Space as selected in the sole and exclusive discretion of SUN 'n FUN. Exhibitor understands and agrees that Exhibitor has no right to use or occupy any specific, fixed, or particular Exhibit Space and has not been granted exclusive use or occupancy of any such Exhibit Space. There is a 25% cancellation fee for each Exhibit Space cancelled. 50% cancellation fee thru February 28th, 2026. No refunds of payment will be made after February 28th 2026.

CLEANING & EARLY BREAKDOWN: All aisles will be maintained by SUN 'n FUN. All Exhibitors are required to clean their Exhibit Spaces at the close of each day. Breakdown and departure are not permitted before 2:00 p.m. on Sunday, April 19th, 2026. Exhibitor breaking down prior to 2:00 p.m. may be denied future Exhibit Space. Vehicle access is permitted at 6:00 p.m. on breakdown day. Any Exhibitor leaving bulk material, garbage, mulch and debris of any kind will have a post-show charge of \$250.00 for indoor Exhibit Space and \$500.00 for outdoor Exhibit Space.

NO SHIPMENTS TO SUN 'n FUN SITE: Shipments prior to the Expo shall only be made by contacting GES. SUN 'n FUN will not accept display or other material at the Expo site.

PERMITTED DISPLAYS: Indoor Exhibitors may install, at their own expense, special signs, displays, counters, shelving, and similar items not to exceed 10 feet in height from the floor along the rear of the Exhibit Space and along no more than 1/2 of the side dividers measured from the rear of the Exhibit Space. No materials may be hung from the hangar structure (e.g., no guide wires from hangar to rafters, no signs attached to walls). Shelving, signs, etc., extending above the side dividers must be approved in advance by SUN 'n FUN and have the back side thereof covered to the satisfaction of the Exhibit Chairman. Outdoor Exhibits shall not exceed 25 feet in height. Noisemakers, disruptive audio, amplifiers, flashing signs, microphones, portable air conditioners, and attention-getting devices are not allowed in any Exhibit Area. Portable air conditioners and generators prohibited inside.

VEHICLE ACCESS: During the Expo, vehicle access is permitted before 9:00 a.m. and after 5:00 p.m. Sunday, April 19th vehicle access at 6:00 p.m. **Vehicles will not be allowed to remain on or at Exhibit Space during the day. Any vehicle outside designated parking area will be towed at owner's expense.**

VEHICLE PARKING: Exhibitors will be issued a designated number of vehicle passes per Exhibit Space. A designated area will be provided for such Exhibitor parking, additional vehicle passes may be purchased. Any Exhibitor with Outdoor Exhibit Space may, with prior approval of SUN 'n FUN, park an R.V. on its Exhibit Space if it is essential to its exhibit in the sole and exclusive determination of SUN 'n FUN; however, it must remain parked on that Exhibit Space for the duration of the Expo. All trucks and trailers must park in the designated storage lot south end of the Pink Lot. **Passenger vehicles will not be allowed at or on Exhibit Space. Vehicles improperly parked will be towed at owner's expense.**

PETS: With the exception of service animals, no other animals of any kind are permitted in the Exhibit Areas.

CERTAIN VEHICLES PROHIBITED: The use of all-terrain vehicles (ATVs), bicycles, golf carts, mini-bikes, roller blades, scooters, and skateboards by Exhibitors at the Expo is strictly prohibited.

HANDICAPPED PARKING: Check with Handicapped Hospitality Center at Main Registration.

NATURE OF EXHIBITS: Only those products documented on this contract as approved by SUN 'n FUN shall be allowed to be sold or shown at Exhibitor's Exhibit Space. Food, drinks, coin-operated games, raffles, film, solicitations, charitable or otherwise, or sales of credit cards or phone cards, or items bearing off-color material, in the sole and exclusive determination of SUN 'n FUN, shall not be allowed.

LOGO USE: SUN 'n FUN does not authorize or grant a contract to any Exhibitors under this Agreement to use its name or trademarked logos or a derivative of, or confusingly similar logos, in any product, whether used for display, sale, or giveaways, without prior written permission of SUN 'n FUN. SUN 'n FUN reserves the right to confiscate any item that violates this provision.

ELECTRIC SERVICE: Each Exhibit Space designated for electric service has 20 amps/120 volts provided. Not to be used for Motor homes. Exhibit Space with 50 amps/240 volts are limited. No additional receptacles are available.

SUBLICENSING OF EXHIBIT SPACE—ASSIGNMENT OF LICENSE IS PROHIBITED: Exhibitors shall not sublicense any Exhibit Space in whole or part, nor display any goods other than those approved by SUN 'n FUN and manufactured or sold by Exhibitor in the regular course of business. In no event shall Exhibitor, Indoor or Outdoor, grant to any person or entity permission to share Exhibit Space or to occupy adjacent Exhibit Areas. Exhibitors shall not assign this contract. Any attempted sublicensing or assignment by Exhibitor shall automatically be null and void.

SOLICITATION OF BUSINESS – RESTRICTIONS: Solicitation will be confined to the Exhibit Areas and to those persons or firms who are bona fide Exhibitors by virtue of paying in full for Exhibit Space and being a party to this contract. Exhibitor shall not conduct business outside Exhibitor's assigned Exhibit Space. All Exhibitors participating in the SUN 'n FUN Aerospace Expo who engage in any form of sales or financial transactions are required to conduct such transactions under their own business or individual name. Exhibitors are strictly prohibited from using the SUN 'n FUN name, logo, or branding in any way that implies SUN 'n FUN is a party to, or responsible for, the transaction. SUN 'n FUN, Inc. does not authorize any Exhibitor to transact business on its behalf and assumes no liability for any goods or services sold by Exhibitors during the event. Failure to comply with this policy may result in removal from the event and/or exclusion from future participation.

PAID CAMPING: Exhibitors are ONLY permitted to camp where a 50-amp RV panel is available in their Exhibit Space (no water) for a fee. Primitive camping is available in Light Plane exhibit spaces as well as the SUN 'n FUN Campground for a fee. Tent camping and pop-up campers are prohibited on all Exhibit Spaces.

SECURITY: SUN 'n FUN will make every reasonable effort to have Security personnel on duty beginning 8 a.m. Tuesday, April 14th, 2026 through and including Sunday, April 19th, 2026.

SAFETY: No smoking, vaping, explosives, inflammables, or other dangerous items will be allowed in the Exhibit Areas. Decorations must be flame resistant. Those Exhibitors conducting demonstrations utilizing open flame, such as welding torches, must furnish appropriate safety equipment, including a fire extinguisher, and must have their demonstrations approved in advance by the SUN 'n FUN Safety and Exhibit Chairman. All Outdoor Exhibitors are required to have a 2A10BC fire extinguisher in their Exhibit Spaces. For safety reasons, all Outdoor Exhibitors using banners, flutter flags, or any signage that involves ground-installed spikes or brackets must remove or properly cover (e.g., with parking cones) all exposed spikes or brackets at the close of Exhibit Hours each day.

AIRCRAFT DISPLAYS: Display aircraft are expected to and shall remain at their Exhibit Spaces. Movement to and from the flight line is discouraged and limited to the following hours: 7:00 a.m. until 8:00 a.m. - 12:00 NOON until 1:00 p.m. - After the airshow until dusk. Only those aircraft having access to the taxiway without causing another display to be moved or dismantled may be taken out of an Exhibit Area. Please plan accordingly.

AIRCRAFT SAFETY: SUN 'n FUN requires that all aircraft in a Display or Commercial Exhibit Area disable the aircraft by (1) Removing the lead from the starter or (2) Disconnecting the battery or (3) Sparkplug leads must be disconnected. Aircraft must remain in that condition until ready to depart the Area.



SUN 'N FUN INSURANCE REQUIREMENTS



INSURANCE, LIABILITY, INDEMNITY RELEASE, AND HOLD HARMLESS: SUN 'n FUN shall not be liable or responsible for any claim, liability, loss, damage, or personal injury, including death, which may occur to the Exhibitor, to the Exhibitor's agents, representatives, servants, employees, customers, providers, suppliers, and/or guests, or to the Exhibitor's property from any cause whatsoever at any time including, specifically, the negligence of SUN 'n FUN and its employees, representatives, servants, or agents.

The Exhibitor hereby expressly releases SUN 'n FUN from and agrees to indemnify and hold SUN 'n FUN harmless from and against any and all claims, liability, loss, damage, or personal injury, including death and from and against property damage of any type or nature, including SUN 'n FUN's negligence.

Without limiting the foregoing, SUN 'n FUN shall not be responsible for the loss of any exhibit or part thereof because of fire or lightning, wind storm or hail, smoke, explosion, riot or civil commotion, vandalism or malicious mischief, burglary, robbery, hold-up, water damage, strike, or any accident involving damage to property or goods in transit, or for any personal injury, including death, that may occur to the Exhibitor, to the Exhibitor's agents, representatives, servants, employees, customers, providers, suppliers, and/or guests, or to the Exhibitor's property from any cause whatsoever at any time or for any exposure to any claims, liability, loss, damage, or personal injury including death.

SUN 'n Fun requires that the exhibitor obtain, at its expense, adequate insurance coverage prior to the expo to insure itself and to **name SUN 'n FUN Fly-In, Inc. and the City of Lakeland including it's respective officers, directors, employees, members, volunteers, affiliates, and divisions are included under the above referenced policy as Additional Insured against any claims, liability, loss, damage, or personal injury, including death, and property damage, whether during transit or while at or during the expo.**

PUBLIC LIABILITY: Each Exhibitor shall obtain and maintain public liability and employee compensation insurance policies which shall include coverage on and to the Exhibitor's property and on and to the Exhibitor's agents, representatives, servants, employees, providers, and/or suppliers while such property and such agents, representatives, servants, employees, providers, and/or suppliers are at, on, in, entering, or leaving the expo site.

In addition, the public liability insurance policy shall include coverage on and to the Exhibitor's agents, representatives, servants, employees, customers, providers, suppliers, and/or guests at, on, in, entering, or leaving the Exhibitor's exhibit space or exhibit area.

Exhibitors displaying aircraft are required to obtain and maintain valid aircraft hull and liability insurance coverage for the duration of their participation. Such coverage shall be designated as primary and non-contributory with respect to any insurance or self-insurance maintained by SUN 'n FUN Fly-In, Inc. and the City of Lakeland.

The policy **must name SUN 'n FUN Fly-In, Inc. and the City of Lakeland including it's respective officers, directors, employees, members, volunteers, affiliates, and divisions as Additional Insured** with respect to liability arising out of the Exhibitor's operations and participation at the event. Proof of such coverage must be provided to SUN 'n FUN prior to any aircraft being brought onto the premises, and SUN 'n FUN reserves the right to deny access or participation in the event if insurance documentation is not received or fails to meet these requirements.

The insurance policies required by this license shall include coverage for any personal injury including death and property damage and shall name **SUN 'n FUN Fly-In, Inc. and the City of Lakeland including it's respective officers, directors, employees, members, volunteers, affiliates, and divisions are included under the above referenced policy as Additional Insured.** minimum liability amount for any of such insurance policies shall be \$1,000,000.00.

INSURANCE CERTIFICATES: All certificates of insurance required hereunder shall be furnished to SUN 'n FUN **on or before March 1, 2026,** as a precondition to Exhibitor entering SUN 'n FUN's property including the expo site and the assigned exhibit space. Exhibitor's insurance policies shall be written on a **primary and non-contributory** basis, and shall not seek contribution from any insurance or self-insurance maintained by SUN 'n FUN. Each policy shall include a provision requiring the insurer to provide **no less than thirty (30) days' advance written notice** to SUN 'n FUN in the event of cancellation, non-renewal, or any material change in coverage. SUN 'n FUN reserves the right to deny access to the premises or revoke exhibit privileges if the required insurance documentation is not received or does not meet the stated requirements.

HANGAR A • B • C • D

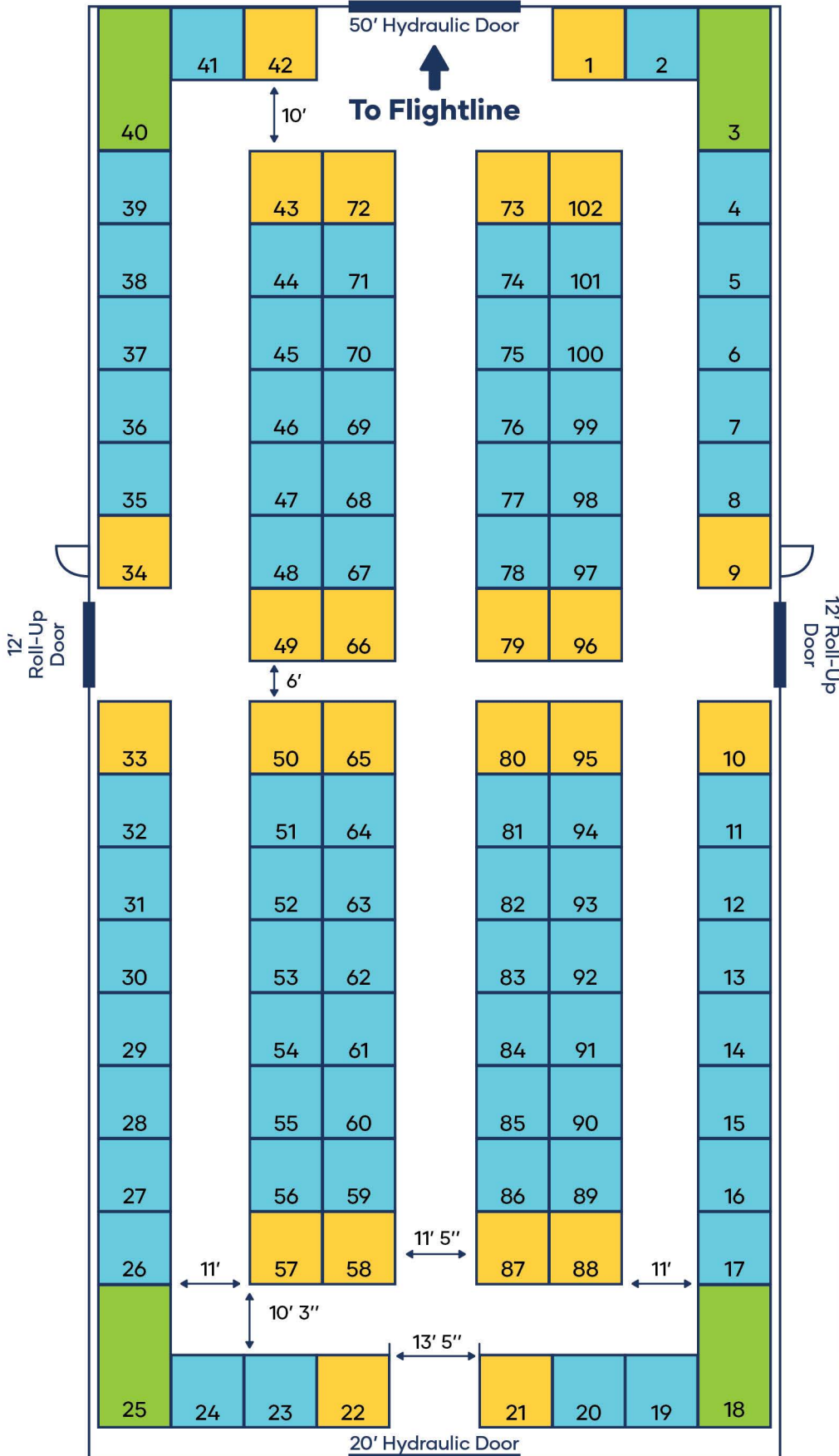

- 10x10 In-Row (\$2,580)
- 10x10 End Cap (\$2,700)
- 10x20 Corner (\$3,460)

*Spaces 1 & 42 are not available in Hangar D

OUTDOOR EXHIBITS



- INDOOR EXHIBITS (A,B,C,D)
- AC AIRCRAFT SPACES
- LD LARGE DISPLAY
- NE NORTH EAST EXHIBITS
- N NORTH EXHIBITS
- MD MANUFACTURERS DISPLAY
- SNF SUN 'N FUN EXHIBITS
- TREES
- GRASS

LIGHTPLANE EXHIBITS

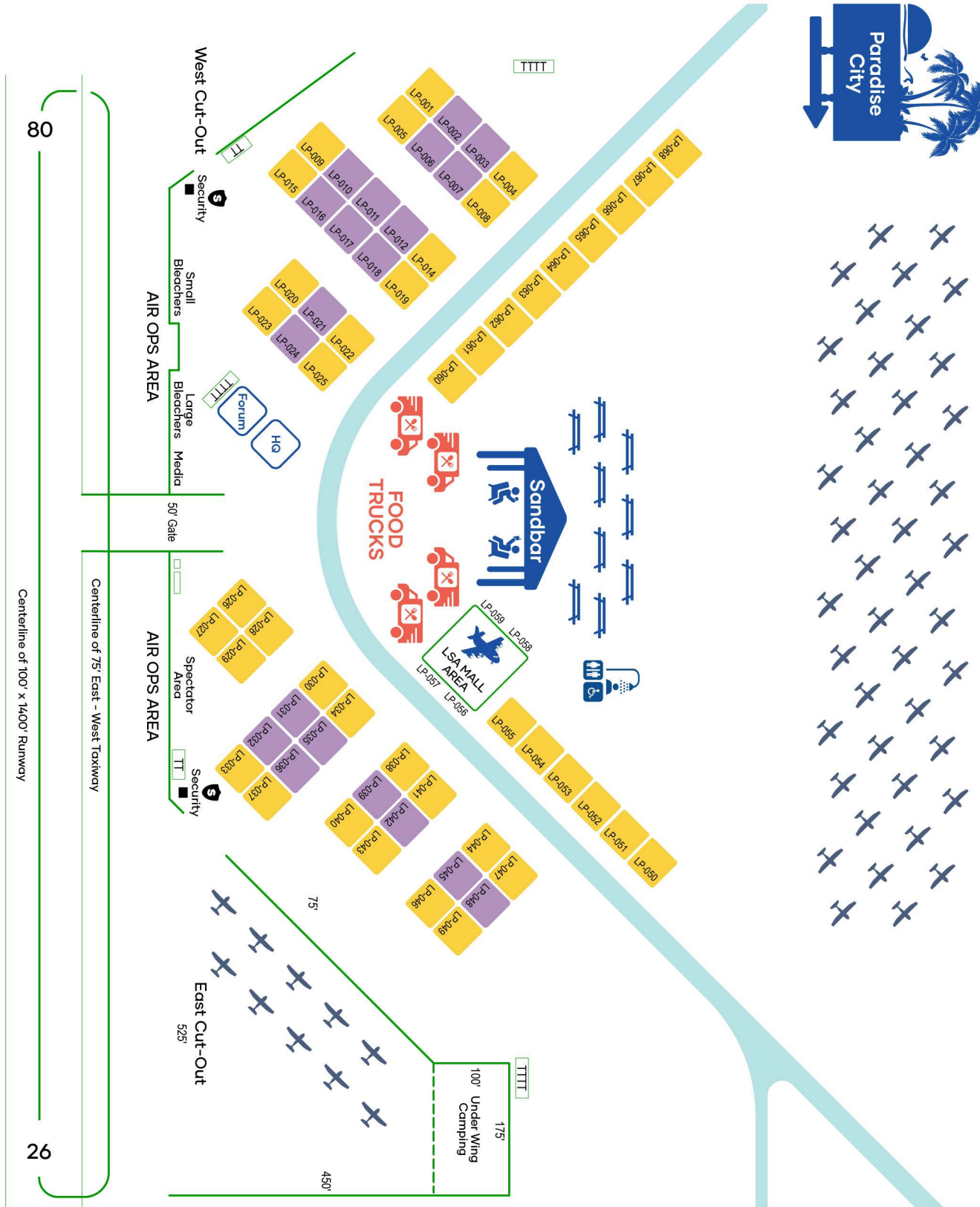

 50x50 FT. - \$1,270
4 Exhibitor/1 Parking pass

 50x50 FT. - \$1,185
4 Exhibitor/1 Parking pass

No electric or phone service available in these exhibit spaces.

FOOD TRUCKS



FAMILY OASIS



INTERNATIONAL OASIS

FPLA2
001

FPLA2
002



- ADDITIONAL EXHIBITS
- AIRSIDE
- CORE AREA

SUN 'n FUN CAREER FAIR

FLIGHT PATH
EDUCATION CENTER

INNOVATION
SHOWCASE

FF-025

FF-026

SUN 'n FUN
MERCHANDISE

JUNIOR ACES
YOUTH ACTIVITIES

FF-019A

FF-019B

FF-018B

FF-018A

FF-018C

FF-017

FF-016A

FF-016B

FF-015A

FF-009A

FF-009B

FF-010B

FF-011A

FF-012

FF-013

FF-014A

FF-007

FF-006

FF-005B

FF-005A

FF-004B

FF-003

FF-002

FF-001

LEENHOUTS WAY

SUN 'n FUN RD.

JAMES C. RAY DR.

← MAIN ENTRANCE

TRAM DEPOT, PARADISE CITY & VINTAGE →

37x75 sq. ft. \$1,650
(6 exhibitor & 2 parking)

75x75 sq. ft. \$2,700
(9 exhibitor & 2 parking)

X SUN 'n FUN CAREER FAIR X

X	1	2	3	4	5	6	7	8
---	---	---	---	---	---	---	---	---

AC	16	15	14	13
AC	17	18	19	20

12	11	10	9
21	22	23	24

33	32	31	30	29	28	27	26	25	X
----	----	----	----	----	----	----	----	----	---

AC

Flight Path Education Center

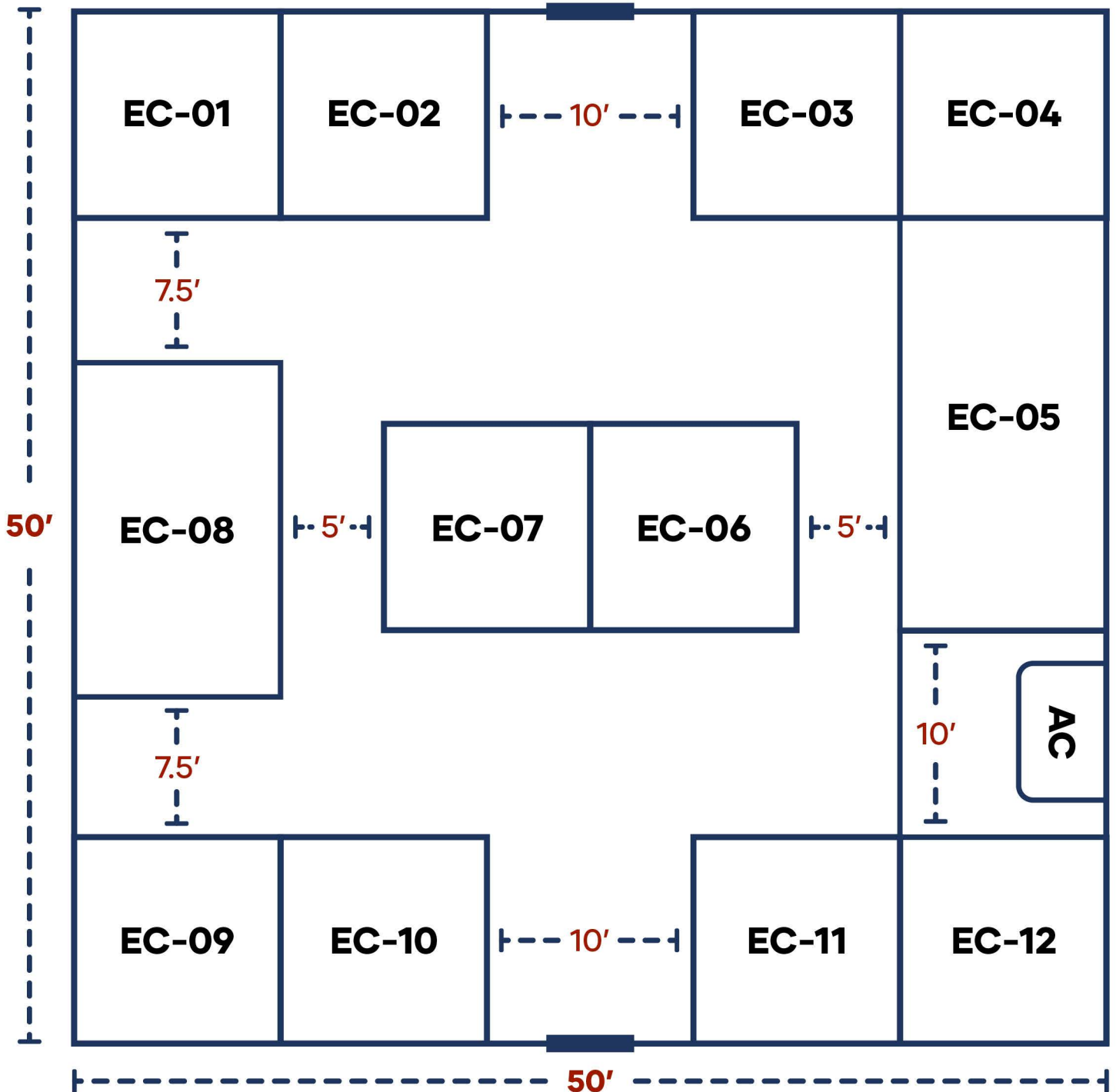

Innovation Showcase

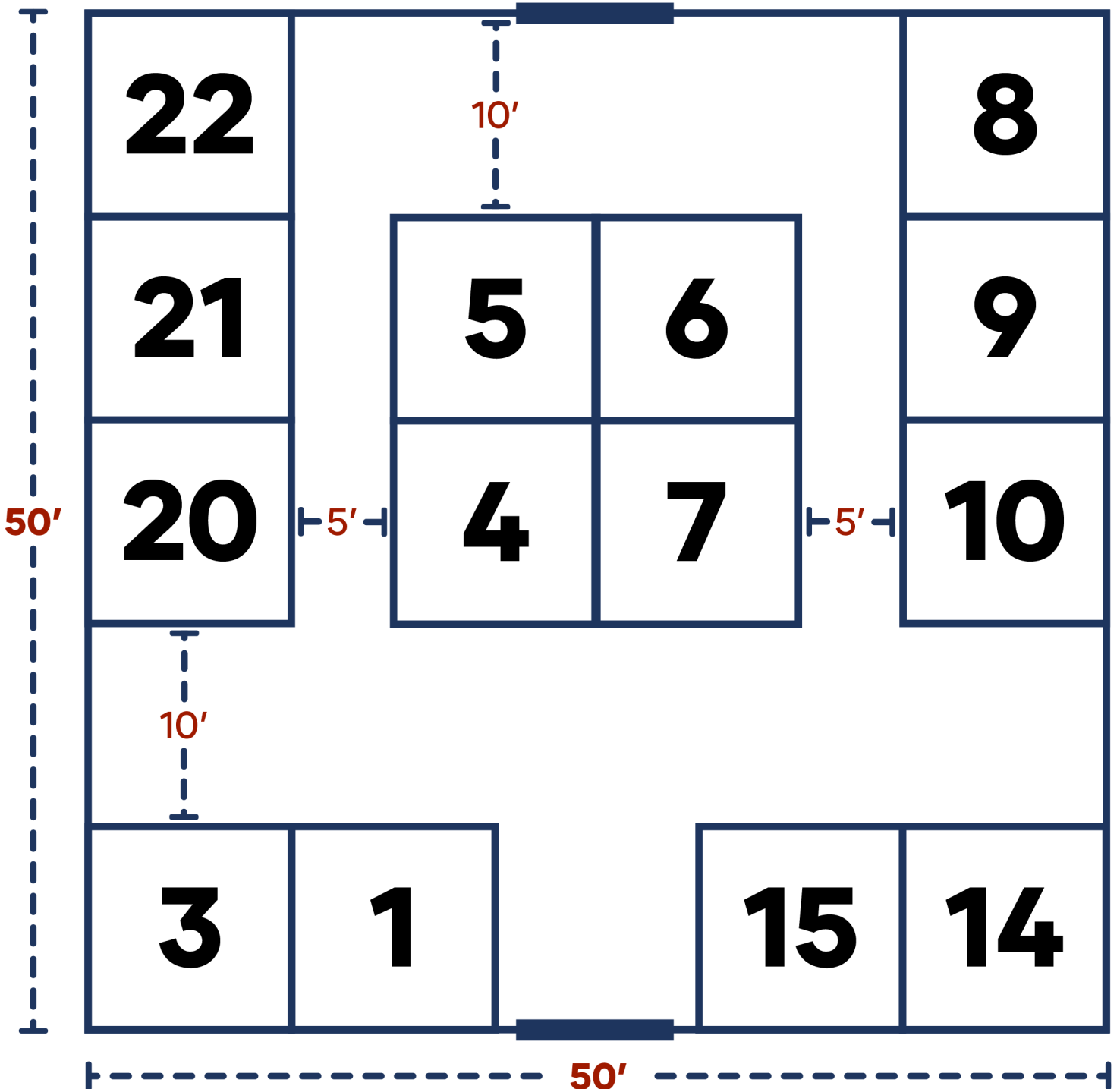

Junior ACES Map

